

United States  
Department of  
Agriculture

Forest Service



Southern  
Research Station

General Technical  
Report SRS-89

# Longleaf Pine Site Zones

Philip J. Craul, John S. Kush, and  
William D. Boyer



---

**The Authors**

---

**Phillip J. Craul**, Professor of Soil Science (Emeritus), SUNY-College of Environmental Science and Forestry, Syracuse, NY, and Senior Lecturer in Landscape Architecture, Harvard University, Graduate School of Design, Manlius, NY 13104-9504; **John S. Kush**, Research Associate, Auburn University, School of Forestry and Wildlife Sciences, Auburn, AL 36849-5418; and **William D. Boyer**, Principal Silviculturist (retired), USDA Forest Service, Southern Research Station, Auburn, AL 36830.

Cover photo: Longleaf pine stand near Flomaton, AL, ca. 1963. (Formerly known as Hauss Park.)

September 2005

Southern Research Station  
P.O. Box 2680  
Asheville, NC 28802

# **Longleaf Pine Site Zones**

**Phillip J. Craul, John S. Kush,  
and William D. Boyer**

# Contents

<b>Foreword</b> .....	v
<b>Introduction</b> .....	1
<b>Methods and Procedures</b> .....	1
Climatic Zones .....	1
Physiographic Provinces .....	1
Soils .....	2
Site Zones .....	2
<b>Results and Discussion</b> .....	2
Climatic Zones .....	2
Physiographic Provinces and Sections .....	7
Soil Orders and Suborders .....	11
The Longleaf Site Zones .....	13
<b>Conclusions</b> .....	15
<b>Literature Cited</b> .....	15
<b>Appendix—Climogram of the 45 Stations Used in the Study</b> .....	16

## FOREWORD

The senior author completed analysis and mapping for a longleaf pine site zones report in 1965. This work was done for the Longleaf Pine Silviculture Project, Escambia Experimental Forest, Southern Forest Experiment Station, Brewton, AL. With the renewed interest in longleaf pine restoration, increased planting efforts on abandoned agricultural lands, and the potential for planting longleaf pine for long-term carbon storage, this work on longleaf pine site zones can be put to practical use. For example, it can help foresters judge what seed sources may be planted safely in what locations. The interaction of climate, soils, and physiography when planting seed sources from one area in another must be considered. It is recommended that plantings of longleaf pine in any one of the six climatic areas (shown in figure 5) use a seed source from the same climatic area. Work by Wells and Wakeley (1970) indicated some consequences of planting seed from one source in another site zone. Their observations suggested that climatic zones may be the most important consideration.

It is recommended that the results of this study be incorporated in the future design and planning of longleaf site evaluation studies and others of a regional nature.

Because nearly 40 years have passed since the site zones work was completed, new data relating to climatic, physiographic, and soils factors have become available. New methods for analyzing climatic data are employed now and soils work has changed in significant ways.

The climate of a region or a locality may be characterized as relatively stable if it is described on the basis of long-term climatological data. The time period covered by the data averages should be at least 30 to 50 years to mask short-term cycles of 3, 5, or 7 to 11 years, which are typical in most climatological data. Longer cycles may have more or less effect on the averages. Also, very long trends, such as global climate change, can cause averages for earlier and later periods to differ. If one employed data for the last 30 years from the stations used in the longleaf site zones study, different climograph patterns might result, modifying the groupings and the differentiations of the climatic zones made in the original study. Other time-related effects are the likely increase in the number of observation stations within the study area and improved instrumentation and data-gathering techniques that would refine the delineation

of boundaries between climatic zones. Over a long period, the potential changes in climatic patterns and zones may influence the distribution of longleaf pine through their influence on factors such as soil moisture, fire hazard, reproduction, insect and disease occurrence, competition with other plant species, and perhaps more profoundly, land use changes.

In the 1960s, ecologists considered that the shapes of climographs of mean monthly temperature and mean monthly rainfall (see appendix) were a sound basis for differentiating among climatic zones. This technique is regarded with less favor today, but the limited availability of sufficiently long term climatological data and the limited number and location of observation stations dictated the choice of climograph patterns as the discriminating factor. More recent advances in graphical discriminant analysis would aid in the more precise differentiation and grouping of the climatic zones based on the climograph patterns, but one may wonder if the work would be any more accurate.

Though climatological maps similar to those of Thornthwaite and others (1958) were available in 1965, none of them contained sufficient detail at an appropriate scale to differentiate the longleaf pine region into climatic zones. The results of Philip Wakeley's (1953, 1959, 1961, 1963) southwide seed source studies provided some evidence of the existence of different zones, as did some unpublished informal growth studies reviewed by Robert Farrar of the Brewton office.

The soils of the longleaf pine region have not changed since the study was closed. Only the series names and taxonomic classifications have been modified, added, or eliminated. But here again, at the scale examined and mapped for the entire longleaf pine range, the delineation of units at the higher categories of classification (including the orders and suborders) should not have changed significantly. The classification, taxonomy, and correlation of more local soil delineations (of the family, series, and perhaps subgroup categories) have probably changed most radically. The family category, being defined primarily on the basis of soil properties that influence plant productivity, was felt to be the most potentially useful soil mapping unit for forestry purposes at the time the study was conducted. However, very few if any family-level maps were available. Moreover, some families were not yet fully defined.

# Longleaf Pine Site Zones

Phillip J. Craul, John S. Kush, and William D. Boyer

## Abstract

The authors delineate six major climatic areas of the longleaf pine (*Pinus palustris* Mill.) region. They subdivide these areas into 21 site zones, each of which is deemed homogenous with respect to climate, physiography, and soils. The site zones are mapped and their climate, physiography, and soils described. The authors recommend that plantings of longleaf pine in any of the six major climatic areas of the longleaf region be made with a seed source from the same area.

**Keywords:** Climatic zones, longleaf pine, physiographic provinces, *Pinus palustris*, site zones, soils.

## INTRODUCTION

The longleaf pine (*Pinus palustris* Mill.) region extends from southeastern Virginia to east Texas. It includes several climatic zones, several physiographic provinces, and many soils. These three site factors are thought to have the most influence on the growth and yield of longleaf pine and other tree species, especially as they affect temperature regimes and moisture conditions under which the trees grow. It is reasonable to assume that these same site factors would affect longleaf pine regeneration and growth as well.

Site study results often are not applicable in areas outside the original study area. The literature on the subject shows that this lack of applicability is usually attributable to differences in the relationships between tree growth and environmental factors from one locality to another. It follows, then, that these differences in environment within the longleaf pine region should be identified and defined, and that environmentally homogeneous areas should be delineated. With this information available, site studies may be executed more soundly and the results interpreted more completely by restricting them to one area or by making observations in all areas. Other studies of longleaf pine problems may be improved as well, particularly on a regional basis.

Unfortunately, little is known of the effect of the environment on longleaf pine regeneration, development, and growth. However, enough information is available to indicate that some differences in environmental influences or effects in the longleaf region cause detectable differences in the growth and yield of the species. The growth and yield differences are sufficiently great to be of concern in the management of longleaf pine forests.

The objectives of this study are to (1) identify and define the climatic, physiographic, and edaphic differences in the longleaf pine region, and (2) describe and delineate longleaf pine site zones (areas homogeneous with respect to significant environmental factors).

## METHODS AND PROCEDURES

### Climatic Zones

We examined climographs of average monthly mean temperature and precipitation for 45 stations in the longleaf region. These stations were selected on the basis of their location with respect to concentrations of longleaf growing stock so that the climographs would be representative of the climate in which the longleaf would be growing. The data for the climographs were obtained from the "Climatic Summary of the United States—Supplement for 1931 through 1952, Series 11" for the eight Southeastern States (U.S. Department of Commerce Weather Bureau 1954). Generally, stations for which at least 20 years' records were available were selected; however, in some cases only stations with a shorter record period could be used.

The climograph shapes or patterns were then compared for similarities that would indicate the locations of climatic zones. We also consulted annual and warm season rainfall maps (U.S. Department of Agriculture 1941) as well as maps of water surplus, water deficit, and potential evapotranspiration for the Eastern United States (Thorntwaite and others 1958). Climatic zones were delineated on the basis of all this information. No actual values for these factors were computed for any of the stations. In 1965, climatological research had not yet reached the point where fine distinction could be made quantitatively.

### Physiographic Provinces

These provinces are delineated on the basis of information in Fenneman (1938), Lobeck (1948), Cooke (1945), and various publications of State geological surveys. The publications on the Southeastern physiographic habitats by Hodgkins (1960, 1965) were also consulted.

## Soils

The soil areas are delineated on the basis of the "General Soil Map of the United States" (U.S. Soil Conservation Service 1964). This map was based on the dominant orders and suborders of the new soil classification system (Soil Survey Staff 1960) and incorporated the latest information available in 1965 on the new system. Due to the transitional period during the 1960s in soil classification in the United States, this site factor was discussed with elements from both the old and the new systems of classification that were available.

The purpose of the present discussion is simply to define the broad soil areas in the longleaf region. No attempt is made to give detailed descriptions for any particular locality. This detail should be obtained from the various county soil survey reports published by the U.S. Soil Conservation Service.

## Site Zones

A separate map was drawn to show areas of homogeneity for each of the three site factors (figs. 1 through 4). A final

map was drawn in which the zone boundaries are delineated by the overlapping homogeneous areas (fig. 5). Thus, areas that are homogeneous with respect to climate, physiography, and soils are shown in figure 5.

## RESULTS AND DISCUSSION

The results of the analyses for the three environmental factors of site are discussed separately. The results are then compiled and discussed in terms of the several regional site zones.

### Climatic Zones

**General**—The Gulf of Mexico is an important source of moisture for air masses that invade the continent from the south. The presence of these moist air masses, above all else, influences the climate of the Southeastern States. During the winter the Southeast is a region of frequent frontal activity, and thus there are periods of onshore and offshore winds.

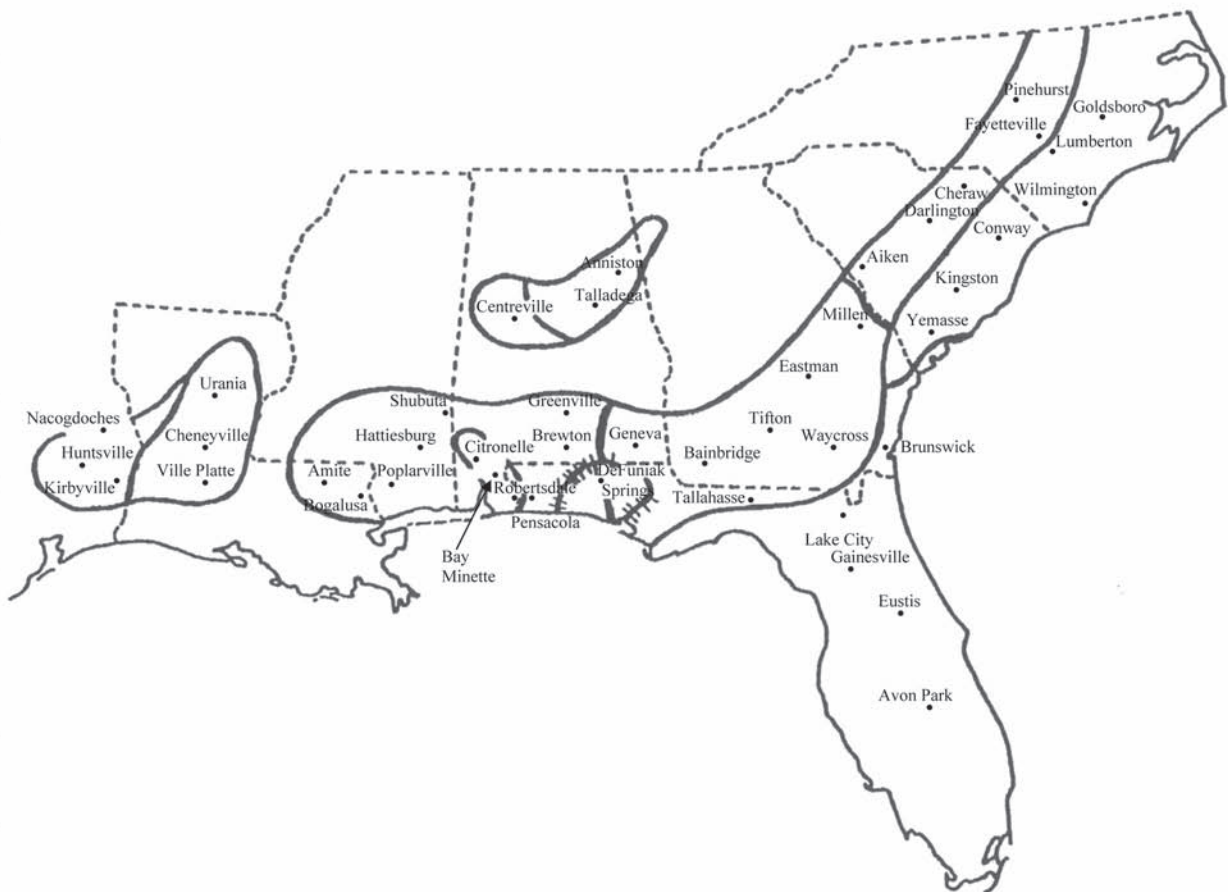

Figure 1—The climatic zones of the longleaf pine region.

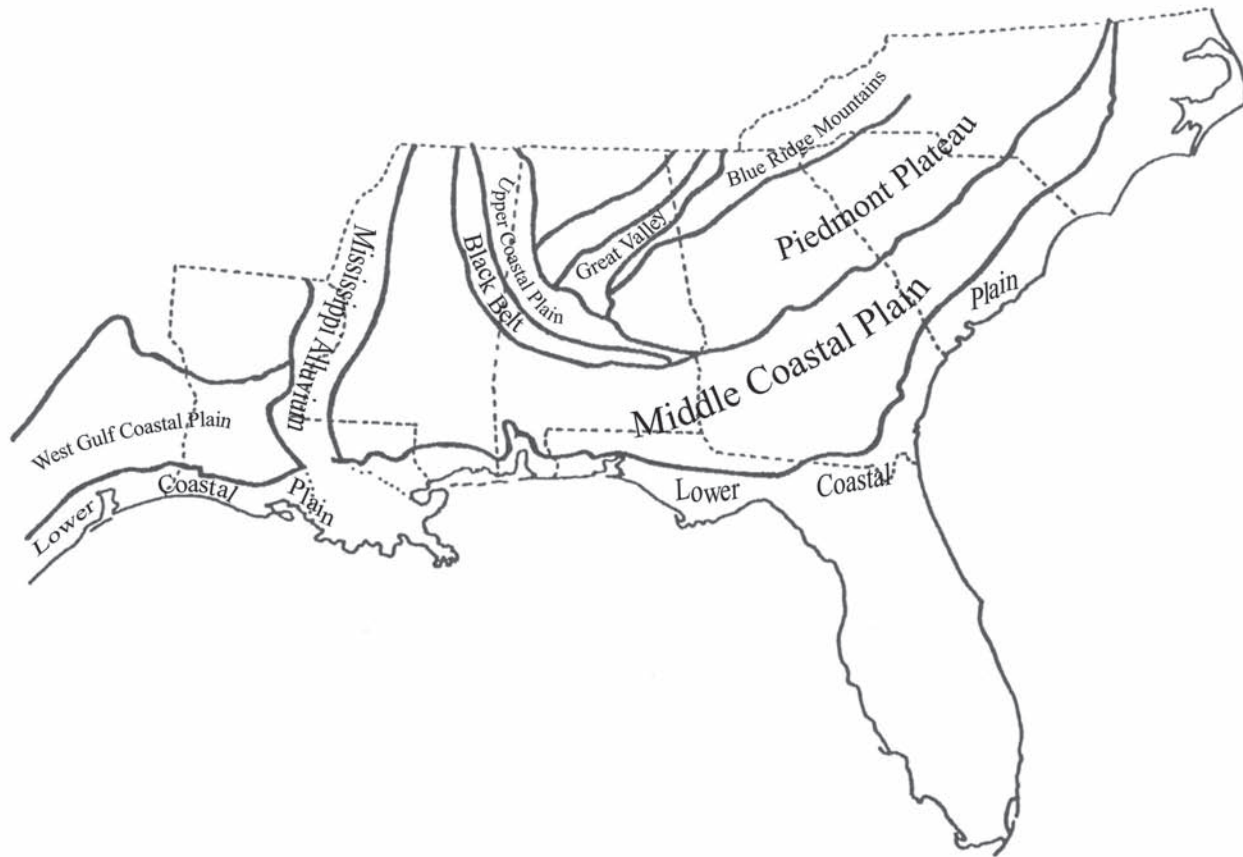

Figure 2—The physiographic provinces of the longleaf pine region after Lobeck (1948).

High temperatures prevail when maritime tropical air moves northward, while north winds produce low temperatures. Cold anticyclones occasionally result in an extreme southward displacement of very cold polar continental air. These cold waves are accompanied by temperatures well below freezing throughout the Southeast and Gulf States. During the winter, precipitation over the Gulf States arises either from frontal lifting or from horizontal convergence. With the high moisture content of maritime tropical air, heavy precipitation occurs quite frequently. This winter precipitation is usually connected with cyclones that develop over the Southern States or over the Gulf of Mexico. The summer precipitation is almost entirely of convective origin—afternoon showers and thundershowers are common, especially inland from the gulf coast. This convective rainfall results in a summer precipitation maximum.

Consistently with the frequent precipitation, the mean cloudiness is high in comparison with that of the western plains. With the cooling of maritime tropical air as it moves northward, light fog and low stratus clouds are sometimes observed during the colder months. Similarly, poor visibility

conditions occur during periods of continuous light warm-front precipitation.

The climate of eastern Texas resembles that of the other Gulf States. Over the South Atlantic States, frequent invasions of maritime tropical air ahead of an eastward moving cyclone result in periods of high temperatures. Florida, because of its insular characteristics, has a relatively high mean winter temperature.

Climate is influenced and modified by geography and topography. Therefore, geography and topography must be considered and discussed in connection with climatic zones.

**Climate of the Lowlands of North and South Carolina—**  
The climate of this area is characterized by that of Goldsboro, Lumberton, and Wilmington, NC; and by that of Conway, Kingstree, and Yemassee, SC (fig. 1 and appendix). With two exceptions, these locations have a precipitation minimum in October. Yemassee, SC, has a January minimum and Wilmington, NC, has a November minimum. The maximum occurs in July except in southeast South



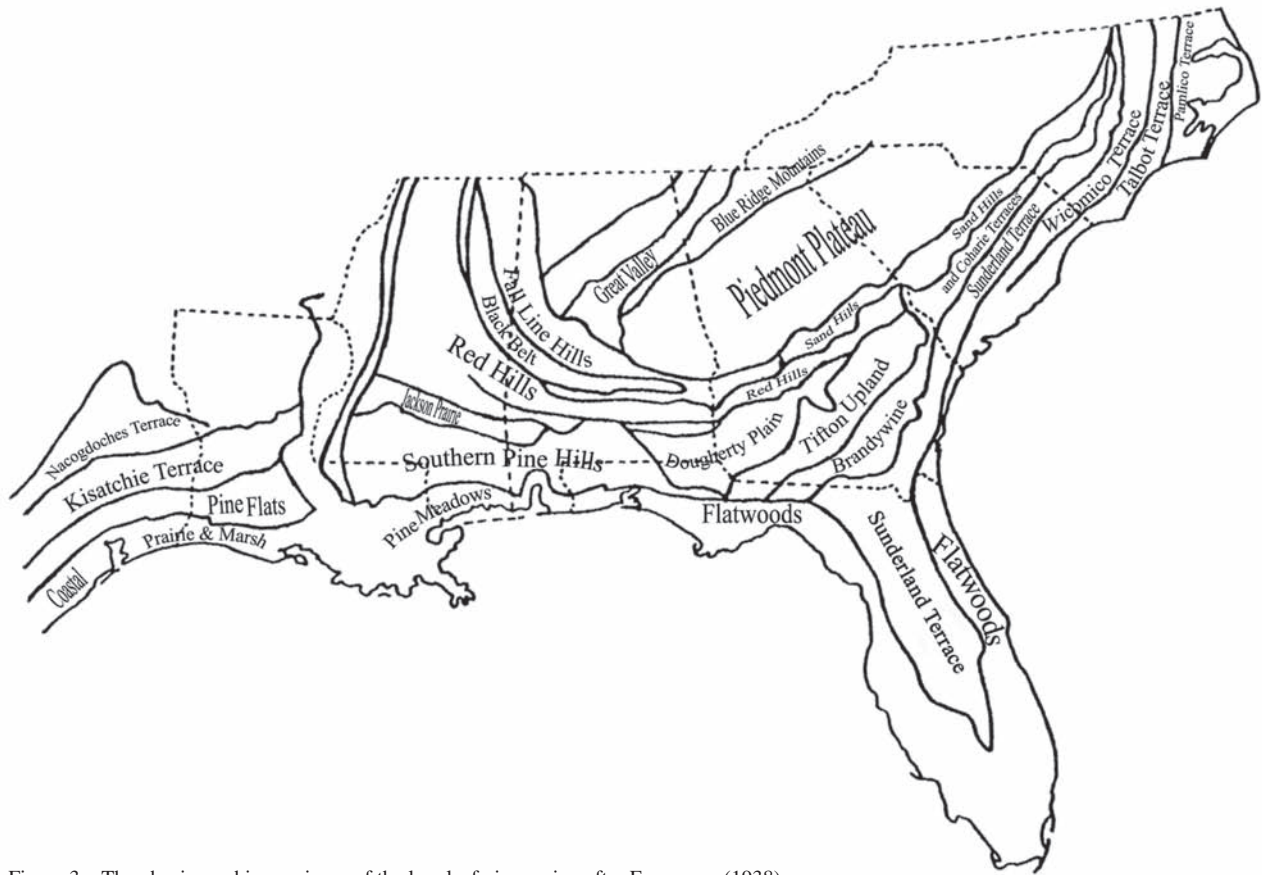

Figure 3—The physiographic provinces of the longleaf pine region after Fenneman (1938).

Carolina; there late summer tropical storms follow the coast and contribute to an August maximum. The mean annual rainfall ranges from 44.46 inches at Kingstree, SC to 50.01 at Conway, SC. All stations, except Goldsboro, NC, exhibit a July temperature maximum and a December minimum; Goldsboro, NC, has a January minimum. The warming cycle is more gradual than the cooling cycle. The annual mean temperature ranges from 62.7 °F at Goldsboro, NC, to 65.8 °F at Yemassee, SC. This section of the coastal lowlands is cooler and drier than areas farther to the south. It is warmer and more moist than the section farther inland (west).

**Climate of the Sandhills of North Carolina and South Carolina**—This discussion applies to the true Sandhills and also an area lying west and inland from the Lowlands. The area's climate is characterized by that of Pinehurst and Fayetteville, NC; and Cheraw, Darlington, and Aiken, SC. The mean annual rainfall ranges from 42.96 inches at Darlington, SC, to 49.44 inches at Pinehurst, NC. All stations have an October rainfall minimum except Pinehurst, NC, which has a November minimum. The maximum occurs in July and August. The average annual mean temperature

ranges from 61.5 °F at Pinehurst, NC, to 63.7 °F at Aiken, SC. The maximum monthly mean temperatures occur in July at all stations, and the minimum monthly mean occurs in January, rather than in December as on the Lowlands. The southern boundary of this zone, approximately the South Carolina–Georgia border, follows the 39.27 inches potential evapotranspiration line of Thornthwaite and others (1958). The inland west boundary is the Piedmont Plateau physiographic province.

**Climate of the Uplands of Georgia**—This section includes a portion of northwest Florida and southeast Alabama. It lies southwest of the previous section and differs from it in having higher annual mean temperatures and two rainfall peaks (February or March and July) rather than just one. The stations whose climates typify this climate are Millen, Eastman, Tifton, and Bainbridge, GA; Geneva, AL; and Tallahassee, FL. The latter two stations are transitional between this section and the Florida section. The annual mean temperature ranges from 66.5 °F at Millen, GA, to 67.6 °F at Bainbridge, GA. The maximum monthly mean temperature occurs in July and the minimum in December.

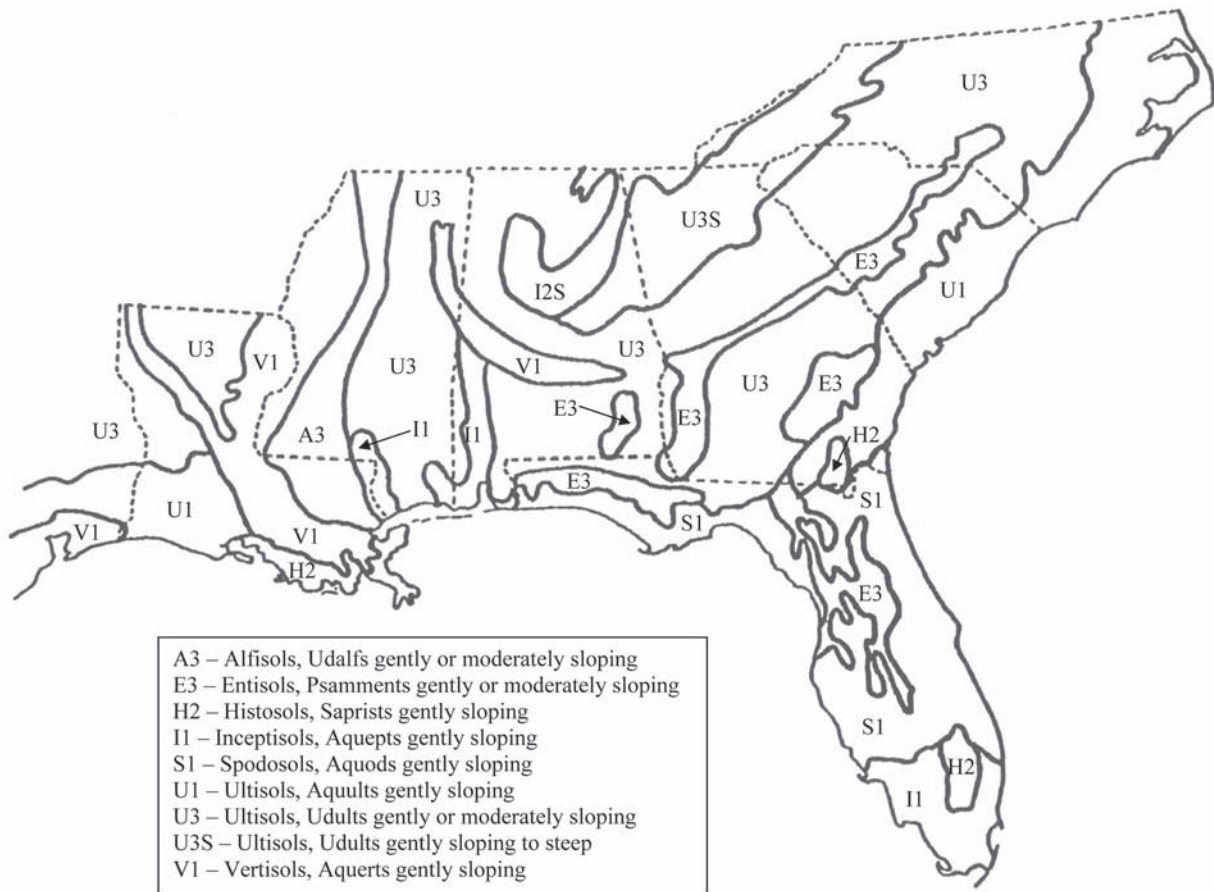

Figure 4—Soil orders and suborders of the Southeastern United States, after the Seventh Approximation.

The average annual rainfall ranges from 44.33 inches at Millen, GA, to 56.77 inches at Tallahassee, FL. This section comes under the influence of both Atlantic and Gulf storms at various times but does not receive the high amount of precipitation that occurs farther south or to the west in Alabama. The rainfall maximum occurs in July, and the minimum occurs in October except at Eastman, GA, where it is in November. This section is also characterized by greater divergence between the rainfall patterns of the warming and cooling cycles than in the sections discussed previously.

**Climate of the Florida and the Georgia Lowlands**—The boundary of this section extends along the coastal lowlands of Georgia and a very small portion of extreme southeastern South Carolina, southward across north-central Florida, and westward to the Gulf southwest of Tallahassee. The climate of this section is characterized by that of the stations located at Waycross and Brunswick, GA, and Lake City, Gainesville, Eustis, and Avon Park, FL. The Avon Park

station is located at the southernmost limit of the long-leaf region in peninsular Florida and also coincides with Thornthwaite's 44.88 inches potential evapotranspiration line. The average annual rainfall ranges from 47.68 inches at Waycross, GA, to 53.51 inches at Avon Park, FL. The annual mean temperature ranges from 68.6 °F at Waycross, GA, to 73.7 °F at Eustis, FL. The stations in this section exhibit the patterns of maritime tropical climate with mild temperatures and high rainfall. Maximum monthly rainfall occurs in July in Florida but in September at Brunswick, GA. Minimum monthly rainfall occurs in November. The maximum monthly mean temperature occurs in August and the minimum monthly mean occurs in January. These extremes occur 1 month later here than in the Uplands of Georgia.

**Climate of the Alabama-Mississippi middle Coastal Plain**—This section includes the area of northwest Florida surrounding Pensacola, FL, southern Alabama and Mississippi, and the Florida Parishes of northeastern

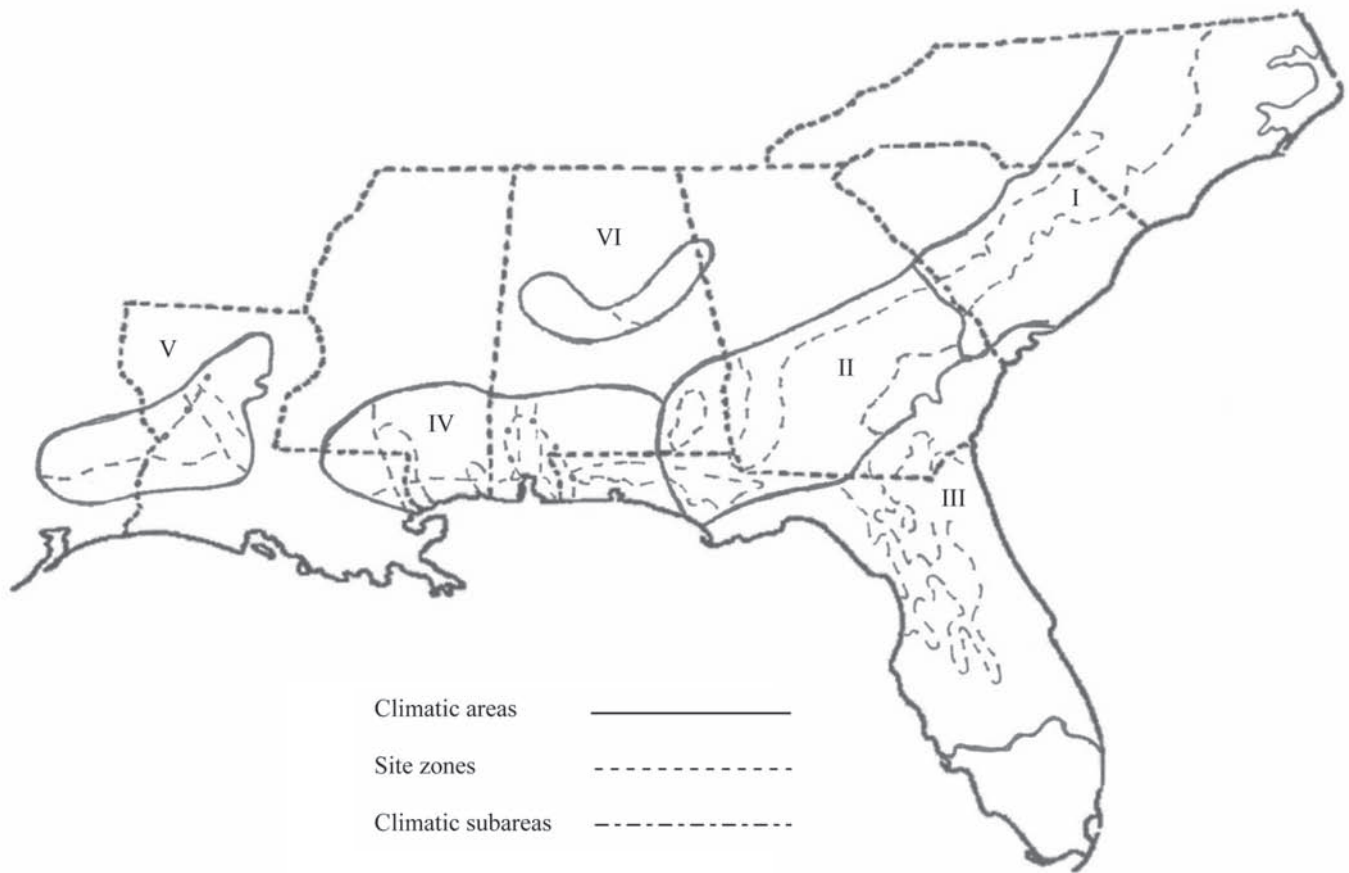

Figure 5—The climatic areas and site zones of the longleaf pine region.

Louisiana. It lies to the west of the Georgia Uplands. The stations whose climates characterize the climate of this section are Brewton and Greenville, AL; Pensacola, FL; Shubuta, Columbia, Hattiesburg, and Poplarville, MS; and Amite and Bogalusa, LA. This section generally comprises what is sometimes considered the East Gulf Coast. A small distinct climatic area located east and north of Mobile Bay is not included in the present section. It will be discussed separately. The average annual rainfall ranges from 58.63 inches at Shubuta, MS, to 63.19 inches at Poplarville, MS. The rainfall patterns are quite similar for all stations and exhibit two distinct and nearly equal maximum monthly peaks in March and July. A third, but much smaller, peak occurs in December. The rainfall minimum occurs in October at all stations, and a secondary low occurs in May at most stations and in June at Shubuta and Hattiesburg, MS, and Bogalusa, LA. The maximum monthly mean temperature generally occurs in August but occurs in July at several stations. The minimum monthly mean temperature occurs in January at all stations. A characteristic that distinguishes this section from the Georgia uplands is the even greater divergence

of the rainfall pattern between the warming and cooling cycles. The average annual mean temperature ranges from 65.6 °F at Shubuta, MS, to 68.0 °F at Pensacola, FL. Hence, the temperature regime in this section is much like that in the Georgia uplands, but it gets more rainfall. This section differs from the Florida section by having two rainfall peaks, rather than just one in July. This section generally coincides with Thornthwaite's 20-inch annual water surplus area, and this surplus is the greatest in the whole longleaf belt and the eight Southeastern States included in this study.

**Climate of the Bay Insert**—This section indents the Alabama-Mississippi section to the east and north of Mobile Bay. The Bay Insert's climate is characterized by that of the stations located at Robertsedale, Bay Minette, and Citronelle, AL. The Mobile Bay exerts an impressive influence on the climatic patterns of the section. The major differentiating characteristic of the insert is its high average annual rainfall, which ranges from 65.70 inches at Citronelle, AL, to 69.24 inches at Robertsedale, AL. Otherwise, the Bay Insert's rainfall pattern is very similar to that of the Alabama-Mississippi

middle Coastal Plain. Whether or not this increase in annual rainfall is sufficient to cause a significant difference in longleaf growth remains to be seen.

**Climate of the Alabama mountains**—Longleaf pine occurs in northern Alabama as a disjunct, separated from the middle and lower Coastal Plains longleaf by the Black Belt physiographic province. The climate of this section is characterized by that of the stations located at Anniston, Talladega, and Centreville, AL. The first two stations are located in the extreme southern end of the Blue Ridge Mountains, in east-central Alabama, while that last is located on the Fall Line Sandhills or upper Coastal Plain in west-central Alabama. This section might possibly be further divided on the basis of climate alone. Anniston and Talladega, AL, have lower annual mean temperatures than Centreville, AL (62.5 °F and 63.6 °F vs. 64.5 °F). The difference in rainfall is even greater (52.20 and 52.52 vs. 57.22 inches). The climate in the Alabama mountains division is completely unlike that of any other portion or section of the longleaf region. Physiography will probably have greater influence on microclimate in this section than elsewhere in the region.

**Climate of the Louisiana-east Texas Coastal Plains**—This area of longleaf pine is separated from the remainder of the region by the Mississippi River Valley and Delta. It is more extensive than the section in northern Alabama. Its climate is characterized by those of Urania, Cheneyville, and Ville Platte, LA; and Nacogdoches, Huntsville, and Kirbyville, TX. On the basis of average annual rainfall, the section could be divided into two parts, the state line forming the boundary. Rainfall at the three stations in Louisiana is 59.13, 62.79, and 59.03 inches per year. Rainfall at the Texas stations is 47.89, 46.58, and 54.14 inches per year. Thus, a 10-inch annual rainfall difference splits this area into two sections. At the stations in Louisiana, the maximum monthly rainfall occurs in January or December with a second peak in March and a third in July. The minimum monthly rainfall occurs in October with a secondary low in June at Urania, LA, and in February at Cheneyville and Ville Platte, LA. A third low occurs in April at Ville Platte, LA, and in February at Urania, LA. The temperature patterns for Louisiana and Texas are similar. The maximum monthly mean temperature occurs in August and the minimum in January. The maximum monthly rainfall occurs in December at Kirbyville and Nacogdoches, TX, and in November at Huntsville, TX. Secondary peaks occur in May and July at Kirbyville, TX, and in January and May at Huntsville, TX. At Nacogdoches, TX, secondary peaks occur in May and July. The 4-inch annual water deficit line of Thornthwaite and others (1958) follows the Louisiana-Texas border through this section.

**Climate Summary**—Several climatic zones within the longleaf pine region may be recognized. Annual rainfall and mean temperatures increase as one proceeds south along the Atlantic coast to Florida and Georgia, and rainfall continues to increase to the west into northwest Florida, southern Alabama, and Mississippi. Annual mean temperatures increase slightly in the latter area, and winter temperatures are milder there than elsewhere except Florida. Rainfall reaches a high maximum at Mobile Bay. Generally, the inland Coastal Plain areas of the longleaf region have lower rainfall and higher mean temperatures than the seaward areas. The mountain portion of the longleaf pine range has a climatic pattern unlike any of the others within the region. The area that lies in Louisiana and east Texas has climatic characteristics that approach those of the moisture-tension zone of the Midwest.

### Physiographic Provinces and Sections

**General**—The longleaf pine region occurs predominantly on the Coastal Plains of Southeastern United States, and for most purposes might be considered as being restricted to them. As figure 2 (Lobeck 1948) shows, the Coastal Plains are further subdivided into the upper, middle, and lower Coastal Plains. These are easily distinguishable topographically and to a lesser extent geologically. The Plains are approximately parallel to the Atlantic and Gulf coasts, turning inward and northward in the Mississippi Valley. The peninsula of Florida is generally considered as being entirely in the lower Coastal Plain province. The landward boundary of the Coastal Plain provinces is the Piedmont Plateau province except in northern Alabama where they border the southern ends of the Great Valley, Valley and Ridge, and Cumberland Plateau provinces.

The Coastal Plain consists of loose or only partly consolidated formations of sand, gravel, clay, or marl, in many places indurated by an appreciable amount of iron oxide or limonite. The slope of this newly emerged surface is very slight, being only 2 to 4 feet to the mile. Because of the gradual uplift of the Coastal Plain and the resulting greater erosion of its inner margin, the older or underlying beds are exposed there in varying amounts. The Coastal Plain exhibits a series of belts roughly parallel with the coast (fig. 3) (Fenneman 1938). The youngest formations are adjacent to the shore whereas older and older beds appear inland, the ages of these formations ranging from present-day and recent Pleistocene sands and clays to Tertiary and Cretaceous beds of similar types.

The several belts of the Coastal Plain vary not only in the geological age of the formation, and in the kind of material

of which they are composed, but also in their topographic relationship. The innermost belt that developed on Cretaceous clays is usually a lowland, whose inner margin is the fall line or fall zone. In the Carolinas and Georgia the Coastal Plain is quite wide. Here the lowland and its adjacent cuesta form a parallel series of plains and dissected uplands called the Fall Line Hills. The other sections of the Coastal Plain have their own distinguishing characteristics.

Throughout its entire extent the seaward margin of the Coastal Plain is fringed with a strip of offshore bars behind which is a more or less continuous lagoon or belt of marshes and ponds.

Figures 2 and 3 (Fenneman 1938, Lobeck 1948) indicate that the physiography of the longleaf pine region may be described simply or in detail depending on the intended purposes. Since it will later be seen that some of the same soils occur in several of the physiographic sections of the region, detailed differentiation of the several sections as illustrated in figure 3 (Fenneman 1938) may not be necessary for defining homogeneous areas. However, it is proposed to describe these sections in detail because they are generally well distinguished in the field, and future work in site evaluation may require their differentiation.

**Fall Line Hills or Sandhills section**—The Cretaceous formations that outcrop and appear in these hills are mainly sand (occasionally cemented) with only minor beds of clay. They are not overlain by a clay formation as in central Alabama (the Black Belt). There are, therefore, no lowlands at the inner edge of the province in the Carolinas and Georgia. This hill belt is more eroded than the plain farther out because it is higher (crests 500 to 600 feet) and has been exposed longer to erosion.

The belt is 20 to 40 miles wide over most of its extent and reaches a maximum width of 50 miles in western Alabama and eastern Mississippi. The half next to the Piedmont or the inner edge is on the Cretaceous outcrop. It has barren yellow sandy soil (Lakeland and Norfolk, etc.) and has little or no flatland remaining at the summit level. In Alabama, altitudes reach more than 700 feet and decline southward to the Black Belt. This is sometimes called the Central Pine Belt of Alabama. An exceptional cuesta near the middle of the belt in Alabama contains some areas of rugged wilderness. The underlying rocks of this zone are from the Tuscaloosa formation. Farther out, the rocks are from the Eutaw formation, and these hills are covered with a bright red residual sand or loam, which is very fertile. The name Red Hills is used to designate them. The Red Hills are sparse north of the Santee River, in the middle of South Carolina.

**Brandywine Terrace**—This terrace occurs in Virginia (and northward), the Carolinas, and Georgia, and lies outward or seaward from the Fall Line Hills. In Georgia, it is separated from the Fall Line Hills by the Tifton Upland.

Most of the gravel once called “Lafayette” lies beneath the terrace and constitutes some remarkable smooth, seaward sloping plains. The preservation of these is enhanced by the porous character of the material, which favors percolation and thus hinders erosion. These flats grade into mild undulations and, near streams, into hills of steeper slope. In southern Virginia and North Carolina the terrace lies only in part on these Tertiary gravels. Locally it truncates older formations among which are Eocene rocks that give rise to the Red Hills. Under such conditions the Brandywine is much eroded, the underlying materials being more readily washed than the Lafayette gravels.

**Tifton Upland**—This area intervenes between the Red Hills and the Brandywine terrace in Georgia, and forms a strip 30 to 50 miles wide. Geologically, it is distinguished from the Red Hills (Louisville Plateau in Georgia) by a Miocene cover (Altamaha Grit), the weathering of which has produced a gray or yellowish sandy soil (Tifton-Norfolk association) clearly distinguished from the red soil on the Eocene. As a result of weak rocks and submature dissection it is a district of gently rolling hills with broad rounded summits, having generally < 50 feet relief and never more than 100 feet except near the larger streams that cross in wide, flat-bottomed valleys several hundred feet deep.

Both the Brandywine and Coharie Terraces are somewhat eroded, and it is difficult to distinguish the two terraces from the Tifton Upland except in elevation. Large flat expanses occur, and the Coharie even bears some extensive swamps or bays. The terraces also resemble the Tifton Upland in that they are covered by a sandy soil that supports longleaf pine and wiregrass.

**Coharie and Sunderland Terraces**—At an altitude of about 215 feet, another level appears prominently in North Carolina. This is the Coharie Terrace. It is succeeded in turn, either gradually or abruptly, by the Sunderland Terrace at 170 feet or less. The Sunderland Terrace appears as a continuously flat landscape, but tributary streams leave no large part of it untouched by erosion. The level of the Sunderland Terrace declines seaward, locally, to the 100-foot contour line without a break before it gives way to the Wicomico, whose maximum height is at that level. In North Carolina the Sunderland Terrace is cut off by the Surry escarpment, at which the level may drop abruptly 30 feet or more to the Wicomico or even the Penholoway level. The Sunderland

Terrace separates what is popularly called the “uplands” from the “lowlands.” The Sunderland and Coharie Terraces form a broken line or belt through Virginia and North Carolina, and much of the area is underlain by late Tertiary gravel not easily distinguished from that which may have been deposited by the waters of the sea that cut the terrace.

As one descends from the Coharie Terrace to the Sunderland in southeastern Georgia, erosion topography is almost left behind. This terrace is flattest in this State and extends into northern Florida, south of the Okefenokee Swamp. It then rises again to the so-called Central Highlands of peninsular Florida. This large area is highly diversified. It includes high swampy plains, the highest in the State, and thousands of lakes. The soils are predominantly sandy. Much of the sand was derived from the Pleistocene marine terraces, a good deal from the Miocene Hawthorn formation and the Pliocene Citronelle formation. The altitude ranges from about 40 feet above sea level in the valleys to 325 feet on the summit of Iron Mountain near Lake Wales, FL. Relief here is due more largely to solution than any other agency. Some scattered hills of gentle slope seem to represent the failure of Pleistocene sediments to obscure older inequalities. Solution is favored by the porous sandy mantle that prevents rain water from running off, retaining it for the slower processes of percolation, descent, and solution. Streams are relatively few.

**Wicomico, Talbot, and Pamlico Terraces**—These terraces constitute what are commonly called the “lowlands” or “flatwoods” of the coastal Carolinas, Georgia, and Florida. They are widest in North Carolina, narrowing through South Carolina, Georgia, and northern Florida. They again become wide in southern Florida where they make up that entire section of the State. The terraces continue northward on the west coast of the peninsula and thence westward.

The terraces are difficult to distinguish in the field because they are all unaffected by erosion, giving rise to broad, flat areas of poorly drained lands consisting of swamps, bogs, bays, and marshes. Topographic maps are the best means to distinguish them. Cooke (1945) gives the following altitudes:

Wicomico Terrace	100 feet above mean sea level (MSL)
Penholoway Terrace	70 feet above MSL
Talbot Terrace	42 feet above MSL
Pamlico Terrace	25 feet above MSL

**The Dougherty Plain**—An upland of a different character reaches from the southeastern corner of Alabama into Florida and spreads widely into southern Georgia. This upland, the Dougherty Plain, is derived from the limestones of the Hatchetigbee Anticline of western Alabama and eastern Mississippi. It is nearly flat, having shallow flat-bottomed or round depressions made by solution. The lime-sink district of Florida has the same character. From the Conecuh River in Alabama to the Flint River in Georgia this limestone plain has the form of a low cuesta. Generally, the inner edge is 400 to 500 feet above the sea. West of the Chattahoochee River the plain slopes southward into western Florida, to the edge of the Southern Pine Hills. Active solution in the plain has transferred most of the drainage from the surface to underground channels.

**The Southern Pine Hills**—The broad area is cuesta-like, with its north-facing scarp, beginning near Vicksburg, passing south of Jackson and on into central Alabama. It is held up mainly by the sandy or gravelly, porous, and therefore not easily erodible, Citronelle (Pliocene) formation. Generally, this rests on the Catahoula (Miocene) sandstone whose importance as a scarp maker increases westward and decreases eastward as its character gradually changes and it becomes the Tampa limestone. Resistance to erosion is aided by actual induration, some of the sandstone being quartzitic, though it is still due mainly to the porous character of the beds. The belt of Southern Pine Hills slopes southward from an altitude of 400 or 500 feet to the limit of the Pleistocene coastal terraces, or about 100 feet. Dissection at the north is generally mature or nearly so. Uncut uplands become broader towards the southern margin, but even here the surface is sufficiently dissected that the limit of the young Pleistocene formations might be drawn fairly well by contrast in topography. The red, orange, and yellow residual loam, which covers the Hills belt, is characteristic of the Citronelle formation. These soils form what is generally considered the Norfolk-Ruston-Tifton association. The Tifton Upland is the eastern continuation of the Southern Pine Hills, being the same physiographically, although its surface beds are not quite the same geologically. This belt is continuous across northern Florida, extending east into the Carolinas (Brandywine and Coharie Terraces), and westward into Texas where it is known as the Kisatchie Terrace. Throughout its extent it has the characteristic sandy soil and the same abundance of longleaf pine.

The Citronelle formation is predominantly sandy but contains lenses of clay. The sands are cross-bedded and generally red; the clays vary in color according to the extent to which they are weathered and are mottled gray and purple, red, or yellow. Clay pebbles or pellets are not

uncommon. Extensive gravel deposits are found in the formation. The thickness of the Citronelle ranges from a thin veneer to 340 feet in southern Alabama.

The Citronelle formation is widely distributed as outliers or as a veneer over older formations (Adams and others 1926). It forms a large part of what was originally called the Lafayette formation, but excludes certain outlying deposits of the Lafayette which are not considered to be river terraces or weathered material derived from several underlying formations.

The original surface of the formation formed a series of plains that slope gently toward the gulf, but it has been so altered by erosion that only a few remnants remain in some locations. The present topography is rolling to hilly and the maximum range of relief is over 450 feet.

**The Pine Meadows**—Between the Southern Pine Hills and the sea in southern Mississippi and southwest Alabama is a strip of coastal lowlands generally < 20 miles wide and narrowing almost to zero width at Mobile Bay. These lowlands are known as the Pine Meadows and are more or less the continuation of the “lowland” terrace of Florida (Wicomico, etc.). The Pine Meadows generally give way to the Southern Pine Hills at a height of not over 100 feet. The landscape is one of faint relief, but low seaward-facing scarps are discernible. The thin covering of Pleistocene sediments is insufficient to obscure completely the older sink-holes or to prevent new ones from forming.

**The Nacogdoches Cuesta and Terrace**—This physiographic section is located in east Texas. North of the Colorado River it is a well developed cuesta, although both slopes are carved by streams. The lower part of the dip slope covers 10 to 25 miles of clays worn down to a gently undulating surface whose fertile soil contrasts with that of the higher zone. This broad ridge owes its existence mainly to the iron content of the underlying sediments, which are largely marl and greensand. Concentration of iron in certain beds which now cap the hills explains their resistance to erosion. Some of the iron is sufficiently concentrated to be used as ore. Iron in the soils also explains the bright prevalent colors of yellow, red, and orange. The entire cuesta north of the Brazos River has a maximum width of 75 miles. Both the rougher marl zone and the smoother clay zone continue south of the Brazos. The rocks that make the Nacogdoches Cuesta are widely exposed in northern Louisiana and southern Arkansas, but the distinctive form is lost there in a broad expanse of low rolling hills.

**The Kisatchie Terrace**—This terrace has already been described as the western extension of the Southern Pine

Hills that is underlain by the Catahoula and Citronelle formations. This is the most prominent relief feature in Louisiana where it reaches maximum development. It is a line of high rugged hills (cuesta) on the north, leveling out to the south into broad gravel-covered flats. Some of the flats extend for 20 to 30 miles, though not without dissection. These represent a once extensive alluvial cover, remnants of the Citronelle.

**The Pine Flats**—In east Texas a seaward-facing scarp separates the flats of the Kisatchie Terrace from the almost featureless plain of the Pine Flats. Above the scarp, the relief increases northward. The description of this upper surface might be applied without change to the Brandywine Terrace at many places on the eastern coast, as the description of the surface below the scarp fits the Sunderland where least eroded. The altitudes also agree. If scarp line of the terrace is continued eastward, it essentially agrees with the southern edge of the Southern Pine Hills belt in Mississippi.

**Alabama Blue Ridge Mountains**—This area comprises the southern extreme end of the Blue Ridge Mountains of Alabama. It is in contact with the southeastward-lying Piedmont Plateau, with the Great Valley (Coosa River) to the northwest, and is bounded on the southwest by the Fall Line Hills. On the western edge of the Piedmont rise the Talladega, Cheaha, and Rebecca Mountains and low hills, together constituting a low monadnock range 50 miles long, in line with the Great Smoky Mountains, though many miles removed from them. These low ridges represent what would have been a continuation of the mountain range had the uplift been greater and the expansion of the newer peneplain less easy. The Cheaha and Rebecca Mountains are formed by undifferentiated sandstones and conglomerates. The lowlands to the southeast are underlain by Talladega slate and Hillabee schist and amphibolite and Ashland mica schist.

These lowlands are the dissected remains of uplands and have relief of 100 feet or more. Longleaf pine occurs here, both in the lowlands and on the mountains of the area as a present day disjunct.

**Physiography summary**—The apparent unifying features of the longleaf region are the more or less continuous conditions of physiography and soils from the Brandywine and Coharie Terraces in North and South Carolina and Georgia, the Tifton Upland in Georgia, and the Central Highlands of Florida, through the Southern Pine Hills of Alabama, Mississippi, northwest Florida, and northeastern Louisiana, to the Kisatchie Terrace and Uplands of central Louisiana and east Texas. The lithology of this belt is

generally contemporaneous with the Pliocene Citronelle formation. This continuity exists, of course, across the several climatic zones of the longleaf region. These physiographic sections are included in the middle Coastal Plain province of Lobeck (1948) (fig. 2). The Wicomico, Talbot (Pensacola), and Pamlico Terraces are considered to be included in the lower Coastal Plain, whereas the Fall Line Hills or Sandhills are considered as being included in the upper Coastal Plain.

### Soil Orders and Suborders

**General**—The soils that occur in the longleaf pine region include members of five orders under the Seventh Approximation (Soil Survey Staff 1960). These orders include Alfisols, Entisols, Inceptisols, Spodosols, and Ultisols. Several of the suborders are also included (fig. 4). Under the 1938 classification these would include the Alluvial, Bog, Half-Bog, Gray-Brown Podzolic, Reddish-Brown, Lateritic, Lithosolic, Planosolic, and Red-Yellow Podzolic great soil groups (U.S. Department of Agriculture 1938).

These soils range from very deep excessively drained sands to poorly drained clays, with or without one or more fragipans in the profile. These soils are derived mainly from the marine sediments of the Atlantic and Gulf Coastal Plains except in a portion of the longleaf region that occurs in northern Alabama. The latter soils are derived from the schist, phyllite, slate, sandstone, and conglomerates of the extreme southern end of the Blue Ridge Mountains.

Approximately 16 soil associations were recognized as occurring in the longleaf region under the 1938 classification. The closest equivalent under the Seventh Approximation is the family category, although the two units do not have similar definitions. The family category holds the most promise for usefulness to the site evaluator, since it is based on grouping of soil series with respect to their similar effect on, and response of, plant growth and yield.

Each of the orders and the included suborders will be described together with several representative series in their respective families. No attempt was made to give lengthy definitions at the time this was written in 1965. Familiarity with the Seventh Approximation was assumed.

**Alfisols**—These are soils having a subsurface horizon that contains an accumulation of clay and a base saturation exceeding 35 percent. The suborder predominant in the area is the Udalf (Alfisols that are usually wet, A3), gently or moderately sloping. This area is located in the loessal fringe belt along the Mississippi River in Mississippi and Louisiana. Representative families and series are: Typic

Hapludalfs, fine silty, mixed, thermic—Lexington; and Typic Fragiuudalfs, fine silty, mixed, thermic—Providence.

**Entisols**—The Entisols are soils either without natural genetic horizons or with only the beginnings of horizons. They thus include many but not all of the previously called alluvial soils, Regosols, Lithosols, Tundra soils, and Low-Humic Gley soils. The central concept of Entisols includes soils in deep regolith or earth with no horizons except a plow layer. The soil may be of any color common to soils as color is not of significance for this classification. Some, particularly the sandy ones, may have thick albic horizons (bleached A2 horizons) lying on B horizons that contrast strongly in color but show little contrast in any other respect.

The predominant suborder in this area is the Psammets (sandy Entisols, E3). These are Entisols that are usually moist in some horizon or layer and that have textures coarser than loamy fine sand to depths of 20 inches or more. They are not saturated in any season and do not have artificial drainage. They include sands that have been in place too short a time to develop diagnostic horizons other than an albic horizon, as well as sand so rich in quartz and other unweatherable minerals that no diagnostic horizons other than an albic horizon can be developed. They range from the calcareous sands on natural levees or recent dunes to the quartz sands commonly found on perhumid Coastal Plains.

These soils are located in or make up the Sandhills of the Carolinas and Georgia, the sand hills surrounding Treutlen County, Georgia, the sandy ridges of the Sunderland Terrace (Central Highlands) of peninsular Florida, and the Sandhills of northwestern Florida and southeast Alabama. The representative families and series are: Typic Quartzipsammets, siliceous, acid, thermic, coated—Alaga (Lakeland); Spodic Quartzipsammets, siliceous, acid thermic, coated—Lake-wood; Ultic Quartzipsammets, siliceous phosphatic, acid, thermic, coated—Gainesville; and Aquic Quartzipsammets, siliceous, acid, thermic, coated—Blanton.

**Inceptisols**—These are soils with one or more of the diagnostic horizons that are thought to form rather quickly and that do not represent significant illuviation or eluviation or extreme weathering. They are most often found on young but not recent land surfaces.

The order includes many of the soils that have been called Brown Forest soils, Subarctic Brown Forest soils, Tundra, Ando soils, Sols Bruns Acides, Lithosols, and Regosols, and a number of associated soils that have been called Humic Gley and Low-Humic Gley soils. It includes soils that are usually moist and that have no spodic, argillic, nitric, calcic,



gypsic, salic, or oxic horizon, or plaggen epipedon, but that have conductivity of the saturation extract of < 1 millimho/cm at 25 °C, and that have one or more of the following: a histic, umbric, or ochric epipedon, a cambic horizon, a fragipan, or a duripan. Since argillic and spodic horizons are absent there cannot be evidences of significant illuviation. Typically, textures are uniform or nearly so.

The predominant suborder is the Aquepts, which are Inceptisols that are saturated with water at some season of the year or that have artificial drainage and have a diagnostic horizon at a depth of < 20 inches. The representative families and series are: Aeric Cumulic Haplaquepts, coarse loamy, mixed, acid, thermic—Mantachie; and Cumulic Haplaquepts coarse loamy, mixed, acid, thermic—Bibb.

**Spodosols**—The Spodosols include primarily the soils that have been called Podzols, Brown Podzolic soils, and Ground-Water Podzols. Not all soils called Podzols are in this order. All mineral soils are included that have a spodic horizon thick enough to be demonstrable after plowing and cultivation for a few years. They are found only in humid regions, and mainly under a coniferous forest. The parent materials are usually siliceous. So far as is known, Spodosols do not form in clayey parent materials. In the tropics, the only parent material of the Spodosols seems to be nearly pure quartz sand. In addition to the spodic horizon, a number of other diagnostic horizons may be present. These include histic, umbric, ochric, and possibly anthropic epipedons. Argillic horizons, duripans, and fragipans may also be found.

These soils have an accumulation of free sesquioxides and organic matter in a subsurface horizon. The predominant Suborder is the Aquods (wet Spodosols) with Histosols and Psammments of the Entisols. The soils are found on the flatwoods or the lower terraces—Wicomico, Talbot (Pensacola), and Pamlico Terrace—Florida. The representative families and series are: Typic Haplaquods, sandy, siliceous, thermic—St. Johns; and Aeric Haplaquods, sandy, siliceous, thermic, noncemented—Leon; and Arenic Haplaquods, sandy siliceous, thermic, coated—Immokalee.

**Ultisols**—The Ultisols have a subsurface horizon that contains an accumulation of clay and has base saturation of < 35 percent. They are restricted to humid climates from the temperate zones to the tropics. Land surfaces are commonly old, or if they are of late Pleistocene age, the parent materials were highly weathered before they were deposited. The native vegetation may have been forest, savanna, or even marsh or swamp flora.

The Ultisols have no oxic or nitric horizons, but they have an argillic horizon. The argillic horizon is not permitted to have tongues of an albic horizon penetrating from the top. In addition, the Ultisols may have a mollic, umbric, ochric, or histic epipedon or a fragipan. Plinthite is often present. These horizons and the plinthite are used to define classes of the Ultisols. The content need not be large, but there must be enough for identification.

Two suborders are represented in this order in the longleaf region. Aquults (U1) are wet Ultisols, gently sloping and found on the flatwoods of the lower Coastal Plain in the Carolinas and Georgia, and again in Louisiana and east Texas (Wicomico, Talbot, and Pamlico Terraces) (fig. 4). The Aquults have been called Low-Humic Gley and Humic Gley soils. They are saturated at some season or have artificial drainage. Representative families and series are: Typic Ochraqults, clayey, mixed, thermic—Bladen and Coxville of the Carolinas and Georgia, and fine silty, mixed, thermic—Caddo of Louisiana and Texas; and the Aquic Hapludults, fine silty, siliceous, thermic—Beauregard of Louisiana and east Texas, and clayey, kaolinitic, thermic—Dunbar of the Carolinas and Georgia.

The second suborder represented is the Udult (U3), gently or moderately sloping, and the gently to steep phase (U38). The former are Ultisols that are usually moist, and these occur extensively on the middle Coastal Plain, especially the Brandywine and Coharie Terraces of the Carolinas and Georgia, and the Tifton Upland of the latter State. Also, they occur on the Southern Pine Hills of southern Alabama and Mississippi, and the Kisatchie Terrace of Louisiana and east Texas. Representative families and series are: Typic Hapludults, fine loamy, siliceous, thermic—Bowie, Norfolk, and Ruston of the Brandywine, Coharie, and Sunderland Terraces of the Carolinas, together with the Plinthic Hapludults, fine loamy, siliceous, thermic—Carnegie and Tifton of the Brandywine Terrace and the Tifton Upland of Georgia and the Southern Pine Hills of south Alabama; and Typic Hapludults, clayey, mixed, thermic—Shubuta, with Ruston and Bowie in the Southern Pine Hills of southern Mississippi and northeastern Louisiana, and the upper Coastal Plain of northern Alabama; and the Typic Hapludults, clayey, kaolinitic, thermic—Faceville and Magnolia of west central Georgia and a portion of southeastern Alabama, and the Bowie and Shubuta families of the Kisatchie Terrace of Louisiana and east Texas.

The Udults, gently sloping to steep phase, are found in the southern end of the Blue Ridge Mountains of east central Alabama. Some soils of the Piedmont Plateau may also be included. Families and series representative of this Suborder

are: Typic Hapludults, fine loamy, mixed, mesic—Tate, and clayey, micaceous, thermic, thin—Fannin.

**Soils Summary**—It appears that the Ultisols are the dominant soil order of the longleaf region. These occur throughout the longleaf region in the Carolinas and Georgia, Alabama, Mississippi, Louisiana, and Texas. The secondary order would be the Entisols, suborder Psamments, which occur in the Sandhills of the Carolinas and Georgia, the Central Highlands of Florida and the Sandhills of northwest Florida, and the sandy outliers in southeast Alabama and southeast Georgia.

The most representative soil families of the longleaf region may be the Typic Hapludults, fine loamy, siliceous, thermic—which includes Bowie, Norfolk, Ruston, Orangeburg and others; Typic Quartzipsamments, siliceous, acid, thermic, coated—Alaga (Lakeland); and the Plinthic Hapludults, fine loamy, siliceous, thermic—Carnegie and Tifton.

### The Longleaf Site Zones

The foregoing discussion seems to indicate that site zones in the longleaf forest region could be distinguished mainly on the basis of climatic differences. This conclusion is based on the fact that the physiographic conditions are generally more uniform on a broad scale than is climate. The vegetation (the longleaf forest) is uniform in a very broad sense. Soils vary widely within physiographic provinces due to local differences in parent material and topography, and require subdivision to that point. Hence, localities first separated on the basis of climatic differences, then on physiographic or soils differences, or both, should be homogeneous with respect to the three factors. It must be borne in mind that the boundaries of these areas and zones are tentative until more information is available on the exact relationships between tree growth and the environment, and are to be revised or eliminated depending on subsequent research results.

**I. The Carolinas area**—The area includes the Coastal Plains of the Carolinas. The southern boundary is the South Carolina-Georgia border, which coincides with Thornthwaite's 39.27 inches potential evapotranspiration line. The western boundary is the edge of the Piedmont Plateau physiographic province.

Three homogeneous zones occur in this area. One is the Fall Line Sandhills of the upper-middle Coastal Plain, with soils characterized by Typic Quartzipsamments of the Entisols. The second zone contains the Brandywine and Coharie Terraces of the middle Coastal Plain. Its soils are characterized by the Typic Hapludults of the moist Ultisols. The third

zone lies on the terraces of the lower Coastal Plain and is characterized by the Typic Ochraquults of the wet Ultisols.

The area's average annual rainfall varies from 43 to 50 inches, and the annual mean temperature ranges from 61 °F to 66 °F. The line between the middle and lower Coastal Plains also acts as a climatic boundary and some minor climatic differences exist between these two physiographic provinces. The area as a whole is generally cooler and drier than the Georgia area lying to the southwest.

**II. The Georgia area**—This area includes a portion of northwest Florida and southeast Alabama, and lies southwest of the Carolinas area. The Georgia area is bordered on the north by the Piedmont Plateau. The southern boundary extends along the coastal lowlands of Georgia, southward across north-central Florida and westward to the gulf, southwest of Tallahassee, FL. This city lies on the boundary. The area comes under the influence of both Atlantic and Gulf storms and differs from the Carolinas in having two rainfall peaks rather than one. It is also characterized by greater divergence between the rainfall patterns of the warming and cooling cycles. The annual mean temperature ranges from 66 °F to 68 °F and rainfall varies from 44 to 58 inches annually.

Three homogeneous site zones occur within this area. The south-westward continuation of the Fall Line Sandhills extends through the central part of the State to the Chatahoochee River, then curves southward to the Florida border. The representative soils are the Typic Quartzipsamments. These same Entisols also occur in the area surrounding Treutlen County at the edge of the middle Coastal Plain, in the area surrounding Dale County, Alabama, and a portion of the Sandhills of northwest Florida. The majority of the land area is composed of the moist Ultisols, Udults, and includes the Typic Hapludults of the Dougherty Plain, Tifton Upland, and Brandywine Terrace of the middle Coastal Plain. Obviously, many other categories are included. A small zone of Spodosols occurs on the lower Coastal Plain below the Florida Sandhills, along the gulf coast. These include mainly the Aquods, which are found further south in peninsular Florida.

**III. The Florida area**—This area consists of the extreme southeastern tip of coastal South Carolina, the lower Coastal Plain of Georgia and peninsular Florida, and a portion of northwest Florida south and west of Tallahassee. The southern boundary is approximately Lake Okeechobee and coincides with Thornthwaite's 44.88 inches evapotranspiration line. The average annual rainfall ranges from 49 to 54 inches, and annual mean temperature ranges from 69 °F to

74 °F. This area exhibits the patterns of maritime subtropical climate with mild temperatures and high rainfall. The physiography is mostly that of the lower Coastal Plain. This includes the Wicomico, Talbot (Pensacola), and Pamlico Terraces along the coasts, and the Sunderland Terrace forming the Central Highlands of the peninsula.

Generally, the following elevations are given for the various terraces:

Sunderland Terrace	Above 100 feet above mean sea level (MSL)
Wicomico Terrace	70 feet above MSL
Talbot (Pensacola) Terrace	42 feet above MSL
Pamlico Terrace	25 feet above MSL

The soils in this area are represented by the Ultic and Typic Quartzipsamments on the Sunderland Terrace, and the Aeric, Typic, and Arenic Haplaquods on the lower terraces.

**IV. The Alabama area**—The eastern boundary of this area is the Georgia area, approximately at Geneva, AL. The northern boundary is the southern edge of the Buhrstone Cuesta in Alabama and Jackson Prairie in Mississippi. It includes northwest Florida and part of southeast Louisiana (the Florida parishes). The average annual rainfall ranges from 59 to 69 inches and the annual mean temperature ranges from 66 °F to 68 °F. This area exhibits two distinct and equal maximum monthly rainfall peaks in March and July. The difference between the rainfall patterns of the warming and cooling cycles is even greater in the Alabama area than in the Georgia area. The temperature range is somewhat less. The Alabama area differs from the Florida area by having two rainfall peaks rather than one. The area coincides generally with Thornthwaite's 20-inch annual water surplus line, which is the greatest in the longleaf belt and the eight Southeastern States included in this study. This area occurs on the widest part of the middle Coastal Plain. The Citronelle and the Catahoula formations underlie this area. It is a continuation of the physiography that begins in the Carolinas on the Brandywine and Coharie Terraces and extends through Georgia on the Tifton Upland into Alabama and Mississippi. Thus, the area is confined mainly to the middle Coastal Plain, although a narrow strip extends along the coast in the lower Coastal Plain near Fort Walton Beach and Pensacola, FL, westward to Mobile, AL, Gulfport, Biloxi, and Poplarville, MS, and Bogalusa and Amite, LA.

As in the Georgia area the predominant soils are the Ultisols or more specifically the Udults, which include the Typic and Plinthic Hapludults of the middle Coastal Plain

(Southern Pine Hills). A portion of the Florida Sandhills is included in this area, and the Sandhills soils are mainly Typic Quartzipsamments. Some Inceptisols (Aquepts) occur along the Mobile and Tombigbee rivers in Alabama, and along the Pascagoula and Pearl rivers in Mississippi. These are Aeric Cumulic and Cumulic Haplaquepts. At the western end of this area occur the Alfisols of the loessal belt east of the Mississippi River. These include Udalfs of the Typic Hapludalfs and Fragiudalfs.

A separate climatic area is recognized within the Alabama area. It lies east and north of Mobile Bay, and is an area of increased annual rainfall—to about 66 to 69 inches as compared with 59 to 63 inches in the remainder of the area.

**V. The Louisiana area**—The Mississippi Valley and its alluvium separate this area from the remainder of the longleaf region. It lies in the eastern counties of Texas and the parishes of central Louisiana on the Nacogdoches and Kisatchie Terraces and the Pine Flats. The climatic pattern exhibited indicates the proximity of the area to the soil moisture tension zone of the Midwestern United States. The 4-inch annual water deficit line of Thornthwaite follows the Louisiana-Texas border and the area is divided on that basis. The annual rainfall for the Texas portion ranges from 48 to 54 inches, while that in the Louisiana portion ranges from 59 to 62 inches. The annual mean temperatures do not differ significantly. The Nacogdoches and Kisatchie Terraces are more or less a continuation of the physiography of the Alabama area and areas further east. They are underlain by the same Citronelle and Catahoula formations and give rise to approximately the same soils, Typic Hapludults.

The Inceptisols found in the Red River Valley are also found in the Louisiana area, but the Red River Valley is not a part of the longleaf pine region. The Pine Flats are on the lower Coastal Plain and have Aquult soils (Typic Ochraquults). Thus, the Louisiana area contains four homogeneous site zones.

**VI. The Mountain area**—Separated from the main portion of the longleaf region by the Black Belt physiographic province, the Mountain area has features unlike those of other divisions in the region. It is located in the extreme southern end of the Blue Ridge Mountains and a portion of the upper Coastal Plain in central Alabama. This division is further subdivided on that basis. The rainfall of this division ranges from 52 to 56 inches annually. The annual mean temperature ranges from 62 °F to 64 °F. The topography, more rugged than elsewhere in the region, has great influence on microclimates in the division. The soils of the two subdivisions differ at the family level but belong to the same subgroup, the Typic Hapludults.

## CONCLUSIONS

Six major areas of the longleaf pine region are recognized and can be delineated without difficulty. These 6 areas are further subdivided into 21 site zones. Each of these site zones is deemed homogeneous with respect to climate, physiography, and soils. Each zone, perhaps, should be studied individually for the relationships between longleaf growth and site. The wealth of literature indicating lack of applicability of results outside of the immediate study area suggests this approach. Further, Hodgkins (1960) states that "The hazards of regression technique can only be avoided by working within small, rather uniform areas." This may be considered as extreme detail, but this approach will yield a clearer understanding of the growth and site relationships over the longleaf region. The zones found not to be significantly different in their factors affecting growth or regeneration can be combined later. In some instances it may be necessary to carry out a given study in only several representative zones; on the other hand, a particular study may have to be carried out simultaneously or successively in all zones.

It is conceivable that these homogeneous site zones may be useful for species other than longleaf pine. However, it must be borne in mind that the zones were defined for longleaf pine.

## LITERATURE CITED

- Adams, G.I.; Butts, C.; Stephenson, L.W.; Cooke, W. 1926. Geology of Alabama. Spec. Rep. 14. Geological Survey of Alabama. 312 p.
- Cooke, C.W. 1945. Geology of Florida. Geol. Bull. 29. Geology Survey of Florida. 339 p.
- Fenneman, N.M. 1938. Physiography of Eastern United States. New York: McGraw-Hill Book Co., Inc. 689 p.
- Hodgkins, E.J. 1960. Estimating site index for longleaf pine through quantitative evaluation of associated vegetation. Society of American Foresters Proceedings. Bethesda, MD: Society of American Foresters: 28-32.
- Hodgkins, E.J. 1965. Southeastern forest habitat regions based on physiography. For. Dep. Series 2. Auburn, AL: Alabama Agriculture Experiment Station. 10 p.
- Lobeck, A.K. 1948. Physiographic diagram of North America. Maplewood, NJ: The Geographical Press. 16 p. + map.
- Soil Survey Staff. 1960. Soil classification, a comprehensive system, 7<sup>th</sup> approximation. Washington: U.S. Department of Agriculture, U.S. Soil Conservation Service. U.S. Government Printing Office. 503 p.
- Thornthwaite, C.W.; Mather, J.R.; Carter, D.B. 1958. Three water balance maps of eastern North America. New York: Resources for the Future, Inc.
- U.S. Department of Agriculture 1938. Yearbook of Agriculture. Soils and Men. Washington: U.S. Government Printing Office. 1232 p.
- U.S. Department of Agriculture 1941. Yearbook of Agriculture. Climate and Man. Washington: U.S. Government Printing Office. 1248 p.
- U.S. Department of Commerce Weather Bureau. 1954. Climatic Summary of the United States-Supplement for 1931-52. Climatography of the U.S. 11-17. Washington: U.S. Government Printing Office.
- U.S. Soil Conservation Service. 1964. General soil map of the United States: coterminous 48 states by dominant orders and suborders of the new soil classification system. Washington: U.S. Department of Agriculture, U.S. Government Printing Office.
- Wakeley, P.C. 1953. The South establishes a major pine geographic seed source study. In: Proceedings of second southern forest tree improvement conference. Atlanta: U.S. Department of Agriculture, Forest Service. 6 p.
- Wakeley, P.C. 1959. Five-year results of the southwide pine seed source study. In: Proceedings of the fifth southern forest tree improvement conference. Raleigh, NC: N.C. State University, School of Forestry: 6-11.
- Wakeley, P.C. 1961. Results of the southwide pine seed source study through 1960-61. In: Proceedings of the sixth southern forest tree improvement conference. Gainesville, FL: University of Florida, School of Forestry: 10-24.
- Wakeley, P.C. 1963. How far can seed be moved. In: Proceedings of seventh southern forest tree improvement conference. New Orleans: U.S. Department of Agriculture, Forest Service: 38-43.
- Wells, O.O.; Wakeley, P.C. 1970. Variation in longleaf pine from several geographic sources. Forest Science. 16: 28-42.

## Appendix

### Climogram of the 45 Stations Used in the Study

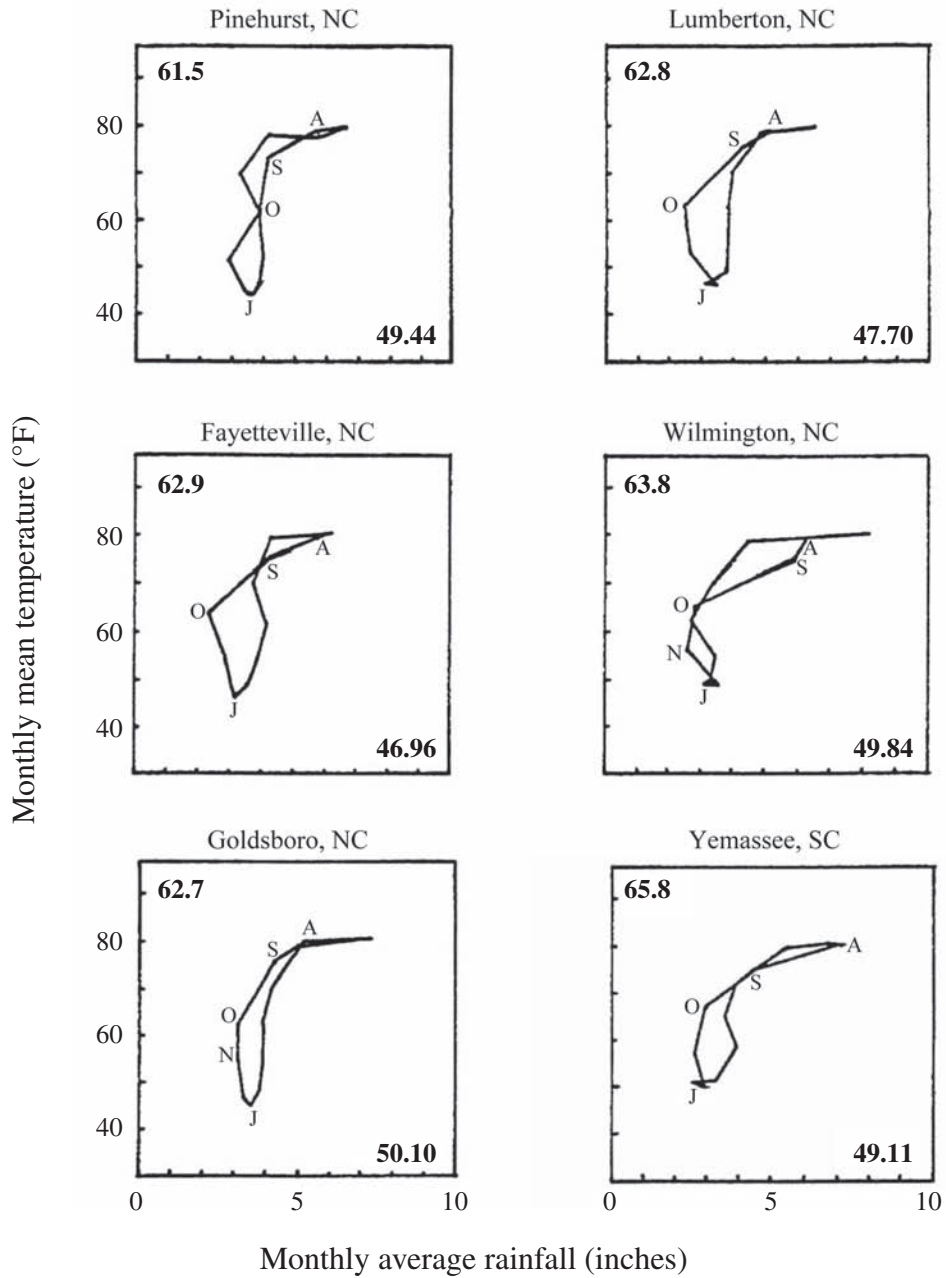

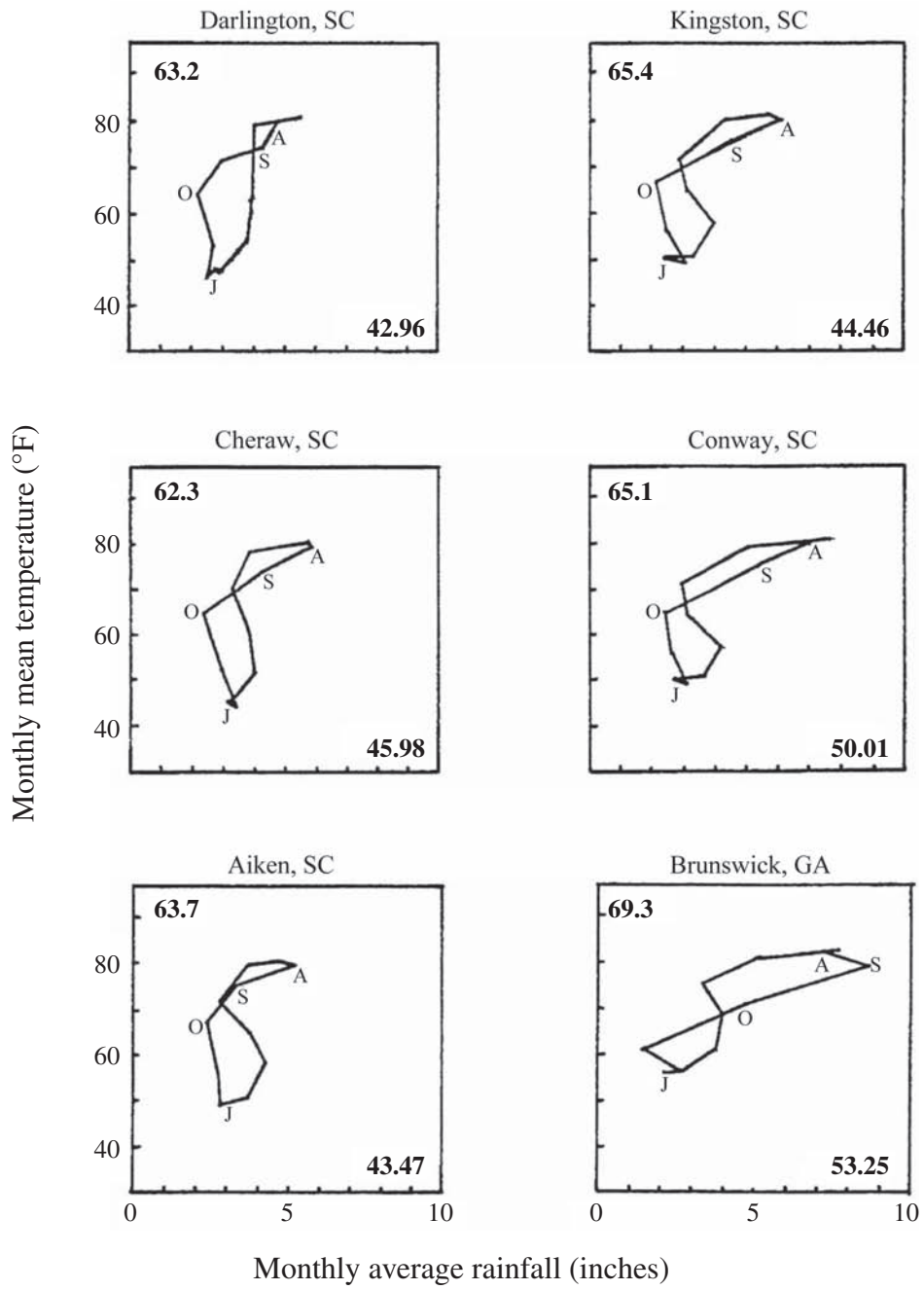

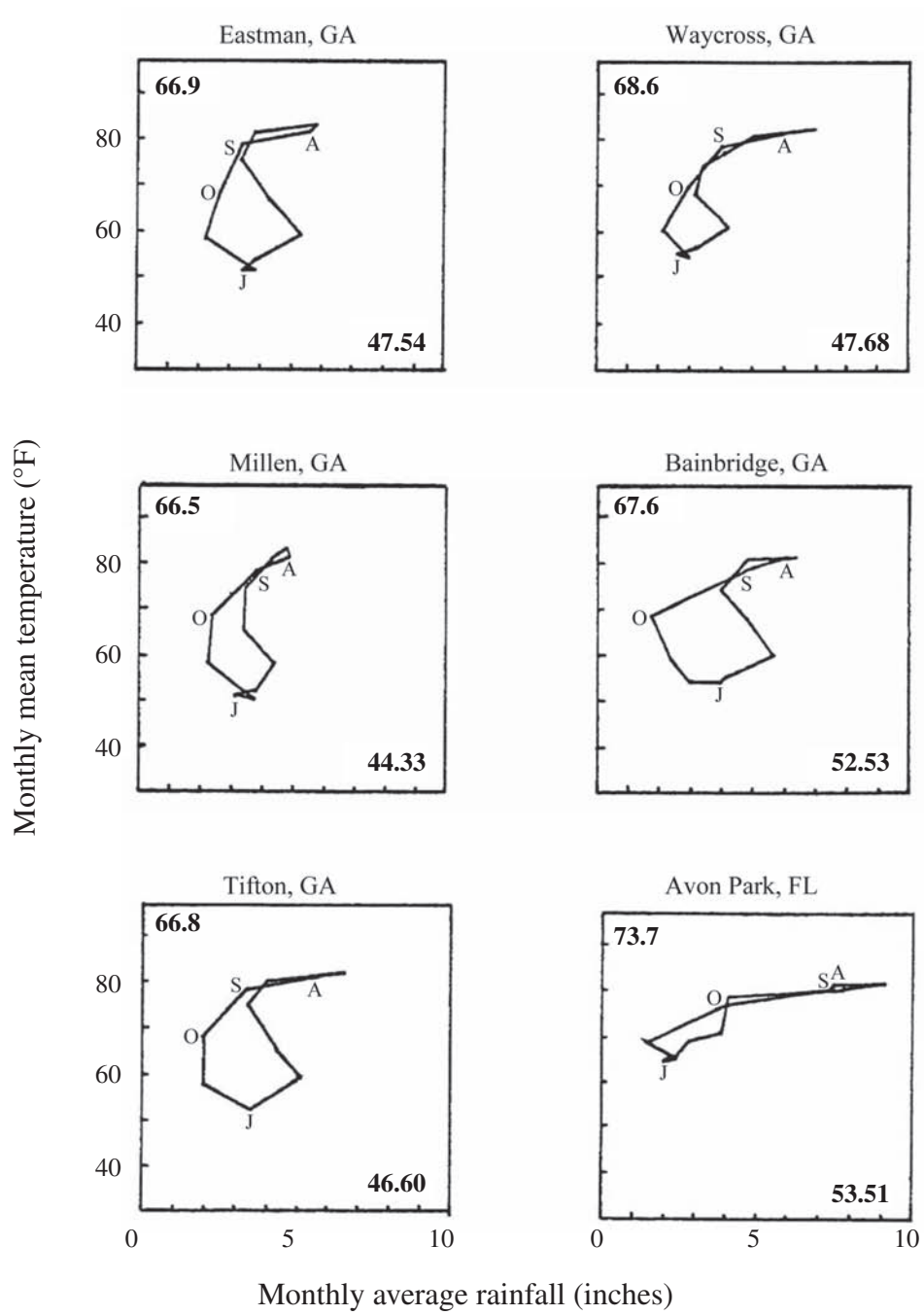

Monthly mean temperature (°F)

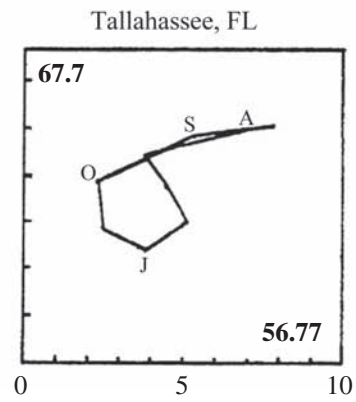
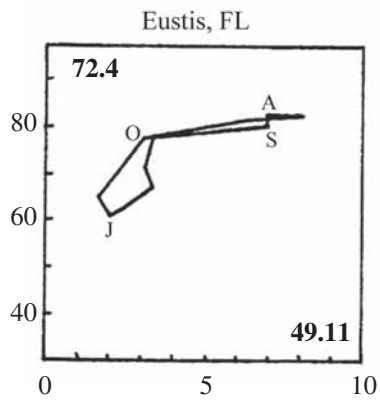
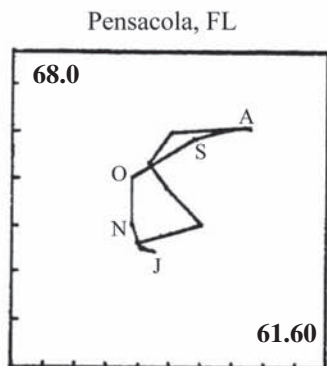
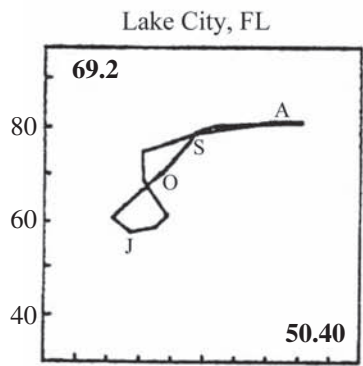
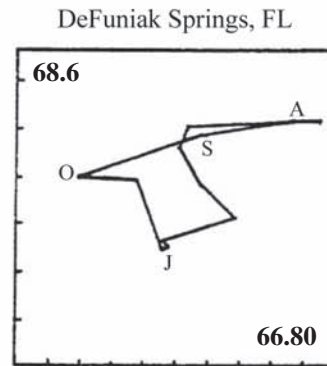
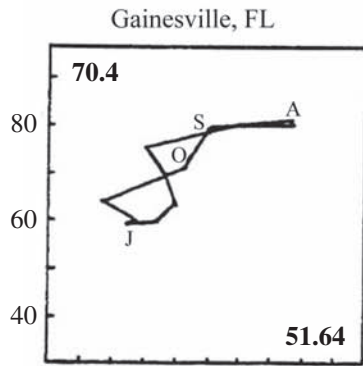

Monthly average rainfall (inches)



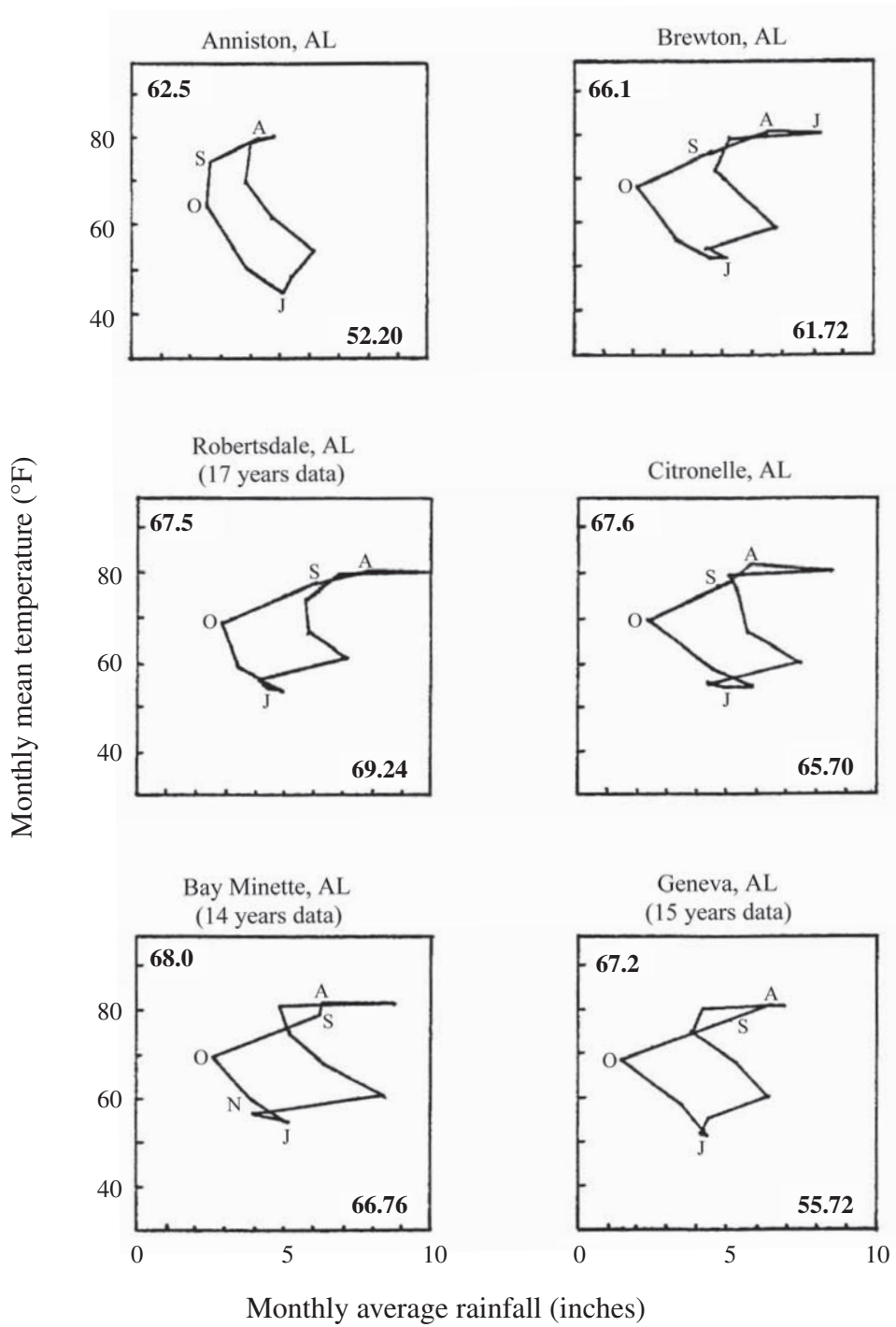

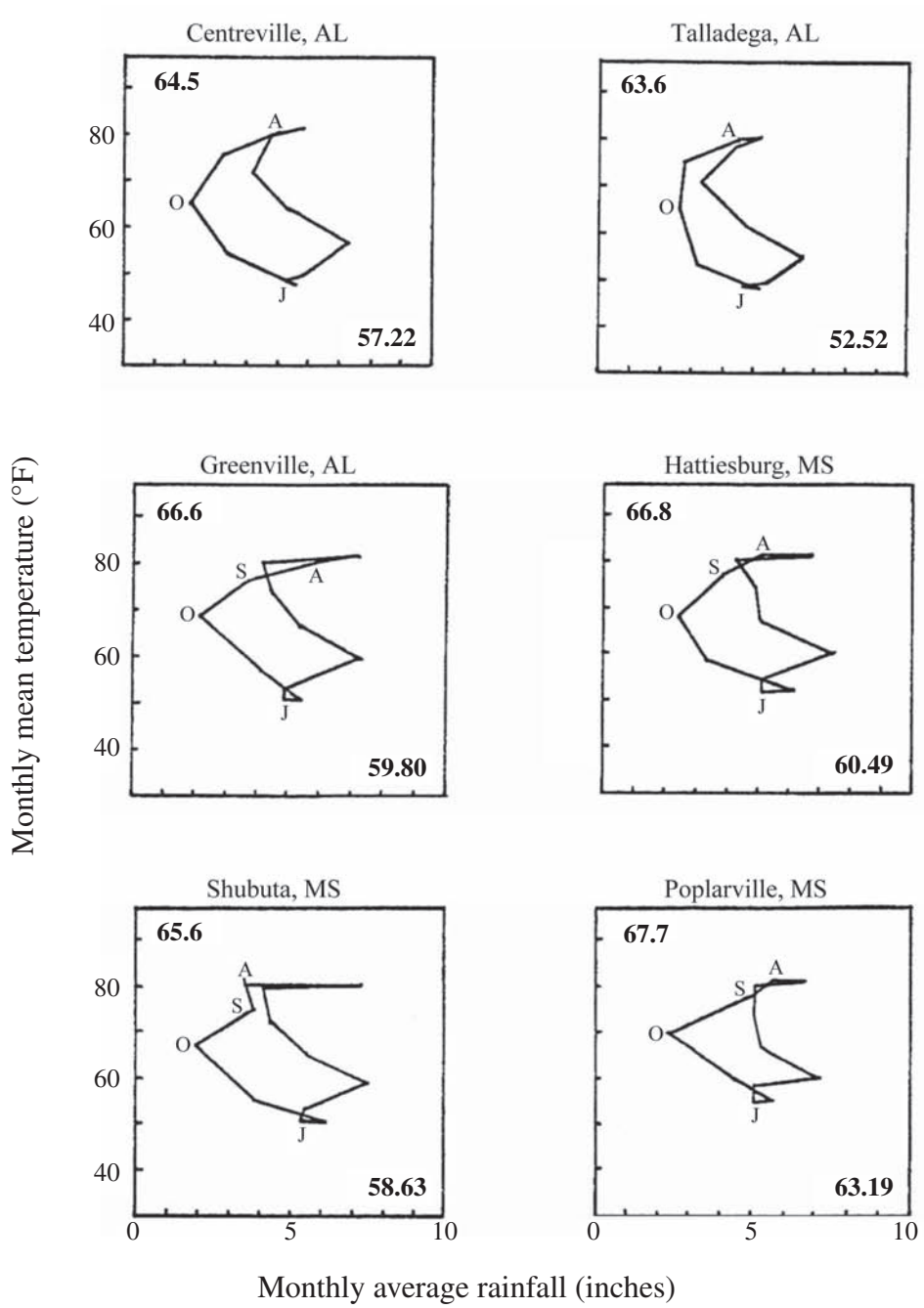

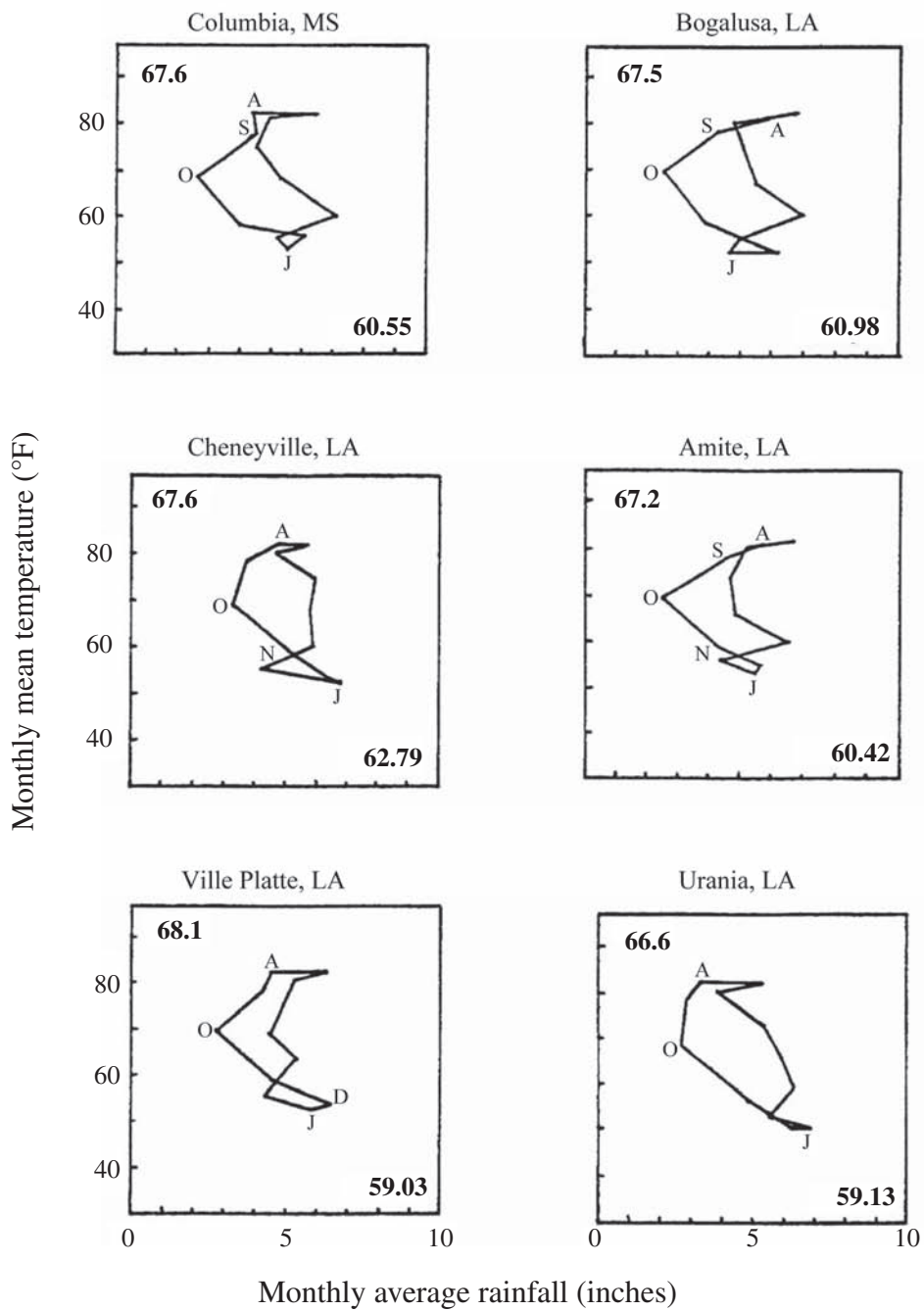

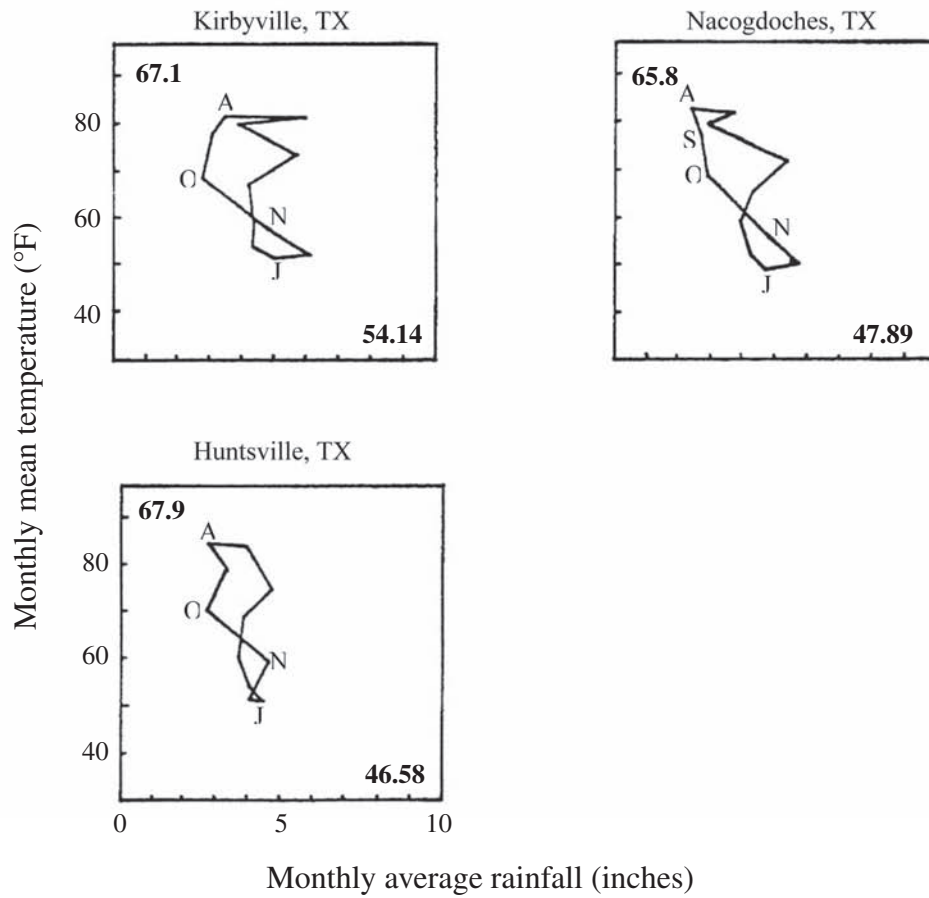

**Craul, Phillip J.; Kush, John S.; Boyer, William D.** 2005. Longleaf pine site zones. Gen. Tech. Rep. SRS-89. Asheville, NC: U.S. Department of Agriculture, Forest Service, Southern Research Station. 23 p.

The authors delineate six major climatic areas of the longleaf pine (*Pinus palustris* Mill.) region. They subdivide these areas into 21 site zones, each of which is deemed homogenous with respect to climate, physiography, and soils. The site zones are mapped and their climate, physiography, and soils described. The authors recommend that plantings of longleaf pine in any of the six major climatic areas of the longleaf region be made with a seed source from the same area.

**Keywords:** Climatic zones, longleaf pine, physiographic provinces, *Pinus palustris*, site zones, soils.



The Forest Service, United States Department of Agriculture (USDA), is dedicated to the principle of multiple use management of the Nation's forest resources for sustained yields of wood, water, forage, wildlife, and recreation. Through forestry research, cooperation with the States and private forest owners, and management of the National Forests and National Grasslands, it strives—as directed by Congress—to provide increasingly greater service to a growing Nation.

The U.S. Department of Agriculture (USDA) prohibits discrimination in all its programs and activities on the basis of race, color, national origin, age, disability, and where applicable, sex, marital status, familial status, parental status, religion, sexual orientation, genetic information, political beliefs, reprisal, or because all or part of an individual's income is derived from any public assistance program. (Not all prohibited bases apply to all programs.) Persons with disabilities who require alternative means for communication of program information (Braille, large print, audiotape, etc.) should contact USDA's TARGET Center at (202) 720-2600 (voice and TDD).

To file a complaint of discrimination, write to USDA, Director, Office of Civil Rights, 1400 Independence Avenue, SW, Washington, D.C. 20250-9410, or call (800) 795-3272 (voice) or (202) 720-6382 (TDD). USDA is an equal opportunity provider and employer.